

AGILE

MARTEX

AGILE

design R&D Martex

“When we think about the office,
we think about people who work there”



en_Agile is a desk, bench and meeting tables system with simple and geometric lines enriched by the possibility of choosing between two top thickness, 14 or 30 mm, and by the variety of the leg finishes.

it_Agile è un programma di scrivanie, bench e tavoli riunione dalle linee semplici e geometriche arricchite dalla possibilità di scelta tra due tipologie di spessori dei piani, 14 o 30 mm, e dalla varietà delle finiture della gamba.

fr_Agile est une collection de bureaux, bench et table réunion avec lignes simples et géométriques. Grande possibilité de choix entre deux typologies de épaisseurs pour les plateaux, 14 ou 30 mm, et la variété des finitions pour les pieds.



en_Desk W. 1800 D. 800 mm with 30 mm thickness White melamine top and Olmo edge; electrified structural cabinet W. 1600 D. 550 H. 610 mm all Olmo melamine.

it_Scrivania L. 1800 P. 800 mm con piano melaminico Bianco e bordo Olmo; contenitore strutturale predisposto per l'elettificazione, L. 1600 P. 550 H. 610 mm tutto melaminico Olmo.

fr_Bureau L. 1800 P. 800 mm avec plateau mélaminé Blanc et chant Olmo, meuble de service structurel L. 1600 P. 550 H. 610 mm avec câblage, en mélaminé Olmo.





en_The desk can be connected to Vertebra cabinets available in three different heights 610, 1229, 1629 mm.
The solutions with Vertebra allow storage at your fingertips and a totally hidden electrification thanks to the removable skirting.

it_La scrivania può essere agganciata a contenitori Vertebra disponibili in diverse altezze 610, 1229, 1629 mm.
Le soluzioni con Vertebra permettono un'archiviazione a portata di mano ed un'elettificazione della postazione totalmente nascosta grazie allo zoccolo ispezionabile del contenitore.

fr_Le bureau peut être accroché aux rangements Vertebra disponible en différentes hauteurs: 610, 1229, 1629 mm.
Les solutions avec la station de travail horizontale Vertebra permettent une classement facile et une électrification caché dans les rangements, avec socle amovible pour accéder aux câbles.

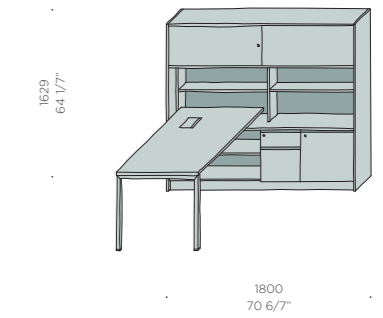
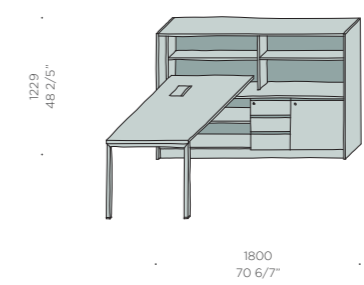
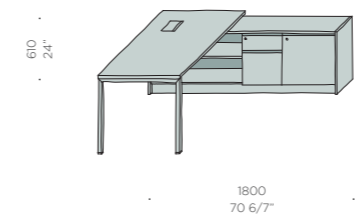





en_Structural pedestal with 4 drawers W. 395 D. 600 H. 720 mm; lacquered built-in handle in finish. It is also available in box/box/total extraction filing drawer configuration.

it_Cassettiera strutturale 4 cassetti L. 395 P. 600 H. 720 mm; maniglia a gola laccata in finitura. È disponibile anche nella configurazione 2 cassetti e cassetto classificatore ad estrazione totale.

fr_Caisson hauteur bureau 4 tiroirs L. 395 P. 600 H. 720 mm; poignées en PVC filantes prise de main dans la même finition. Disponible aussi avec 2 tiroirs et tiroir D.S. avec extraction totale.



en_Pedestal on wheels W. 800 D. 550 H. 645 mm with hinged door and 3 drawers, in Avio matt lacquered. It is available in different configurations, with doors, open units, or with filing drawers.

it_Contentitore su ruote L. 800 P. 550 H. 645 mm con anta battente e 3 cassetti, in laccato opaco Avio. È disponibile in diverse varianti, con ante, vani a giorno, o con cassetti classificatori.

fr_Meuble de service L. 800 P. 550 H. 645 mm avec roulettes, porte battante et 3 tiroirs, en laque mat Avio. Disponible avec portes, niches ouvertes ou tiroirs classeur.



en_Cable flap for tops th. 14 and 30 mm

it_Passacavi per piani sp. 14 e 30 mm

fr_Top-access pour plateaux ép. 14 ou 30 mm

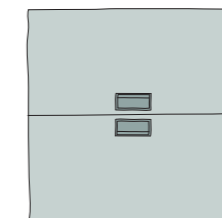

en_Desk long flipper for tops th. 30 mm

it_Flipper per piani sp. 30 mm

fr_Flipper pour plateaux ép. 30 mm

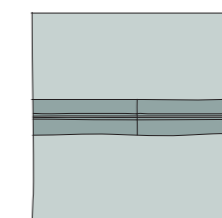

en_Scalloped tops th. 14 and 30 mm

it_Scanso per piani sp. 14 e 30 mm

fr_Passage des câbles pour plateaux ép. 14 ou 30 mm

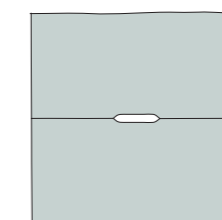

en_The simple and essential geometries of the legs are synonymous of lightness and make this collection suitable for all office spaces. In the picture, bench W. 1600 D. 1600 mm with 14 mm thickness Crema lacquered top and legs and Ocra lacquered screen.

it_Le geometrie semplici ed essenziali delle gambe, sono sinonimo di leggerezza e rendono questa collezione adatta a tutti gli spazi ufficio. Nella foto bench L. 1600 P. 1600 mm con piano e gambe in finitura laccato Crema e screen laccato Ocra.

fr_Le géométries simples et essentielles des pieds sont synonymes de légèreté et rendent la collection parfaite pour toutes les espaces bureau. Dans la photo bench L. 1600 P. 1600 mm avec plateaux et pieds en finition laquée Crème et cloisonnettes laquée Ocra.







en_Each workstation can be enriched with accessories that make the workplace even more functional. Melamine or fabric screen, underdesk drawers, spacious pedestals or monitor holder are just some examples of Martex proposal.

it_Ogni postazione può essere arricchita da accessori che rendono più funzionale il posto di lavoro. Screen in melaminico o tessuto, cassettini sotto piano, capienti cassettiere o bracci portamonitor sono solo alcuni esempi della proposta Martex.

fr_Chaque espace de travail peut être enrichi par accessoires pour devenir encore plus fonctionnel. Cloisonnettes en mélaminé ou tissu, tiroir sous le plan de travail ou caissons, bras support écran et électrification intégrée sont seulement quelques exemple.



en_Bench in line W. 2000 D. 800 mm with overhead cabinets with sliding doors. Panels in cork or in writable melamine, accessory bars can be integrated according to each requirement.

it_Bench in linea L. 2000 P. 800 mm con contenitori overhead ad ante scorrevoli. In base alle esigenze possono essere integrati pannelli in sughero o melaminico scrivibile e barre porta accessori.

fr_Bench en ligne L. 2000 P. 800 mm, rangements suspendus avec portes coulissantes. Panneaux en liège ou en mélamine avec possibilité d'écrire, rails pour accessoires peuvent être intégrés.





en_Workstation W. 2200 D. 1600 mm
connected up to 2 structural storage H. 1100
mm with hinged doors and built-in handle.

it_Composizione L. 2200 P. 1600 mm
agganciata a 2 contenitori H. 1100 mm,
ante battenti con maniglia a gola.

fr_Configuration L. 2200 P. 1600 mm avec
bench, bout de bench et armoires H. 1100 mm
avec portes battantes et poignées filantes.



en_Essential, flexible and functional workstations, thanks to the variety of cabinets, available in different heights and configurations, favour an organized workspace with a high level of comfort.

it_Postazioni essenziali, flessibili e funzionali, che grazie alla varietà dei contenitori, disponibili in diverse altezze e configurazioni, permettono di organizzare la postazione creando un alto livello di comfort.

fr_Configurations essentiels, flexibles et fonctionnels, que grâce à la variété des armoires, disponibles en différentes hauteurs et configurations, permettent d'organiser l'espace de travail en créant un haut niveau de confort.





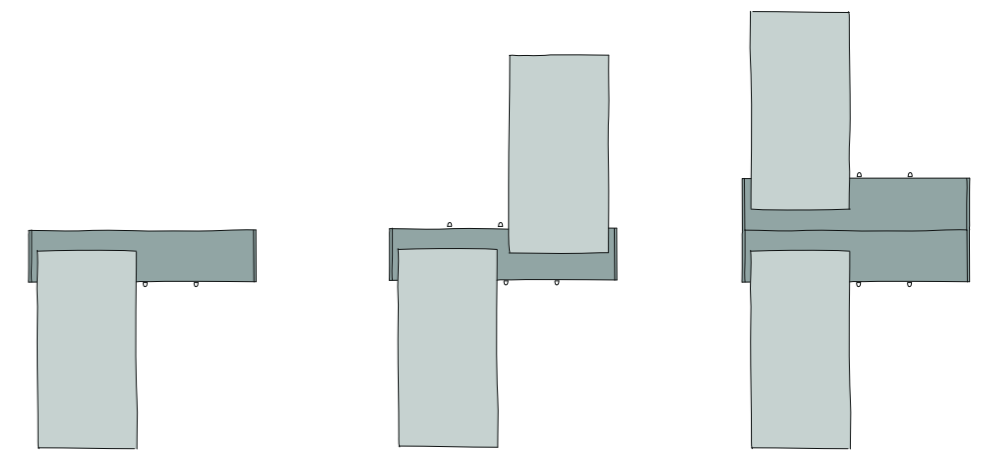

en_One sided Vertebra

it_Vertebra monofacciale

fr_Vertebra mono face

en_Double sided Vertebra

it_Vertebra bifacciale

fr_Vertebra deux faces

en_Double Vertebra

it_Vertebra doppia

fr_Vertebra double







en_All meeting tables can have an integrated and completely hidden electrification giving functionality to its timeless design.

it_Tutti i tavoli riunioni hanno la possibilità di avere un'elettificazione integrata e completamente nascosta conferendo funzionalità al suo design intramontabile.

fr_Toutes les tables réunions ont la possibilité d'avoir une électrification intégrée et complètement cachée, en conférant fonctionnalité à son design impérisable.

Finishings

MEL 14 - MELAMINE TH. 14 MM / MELAMINICI SP. 14 MM / MÉLAMINE ÉP. 14 MM



MEL 30 - MELAMINE TH. 30 MM / MELAMINICI SP. 30 MM / MÉLAMINE ÉP. 30 MM

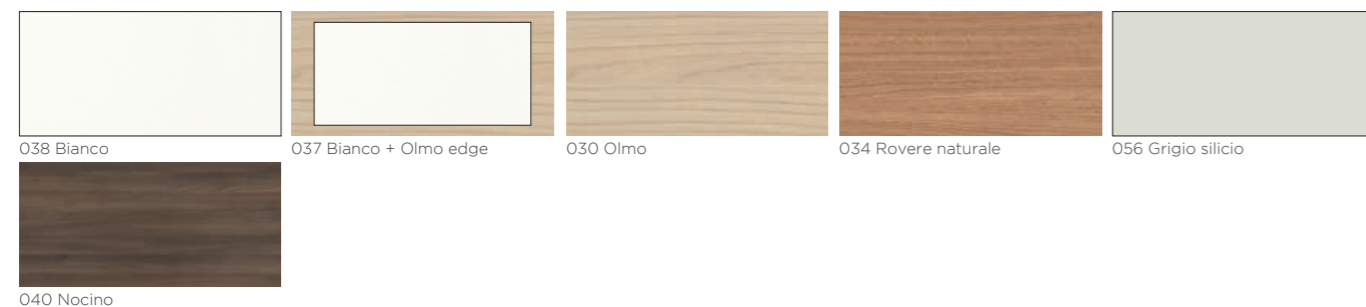

LAC - MATT LACQUERED COLOURS / LACCATI OPACHI / LAQUÉ MAT



CAT. C - FABRIC ANGEL / TESSUTO ANGEL / TISSU ANGEL

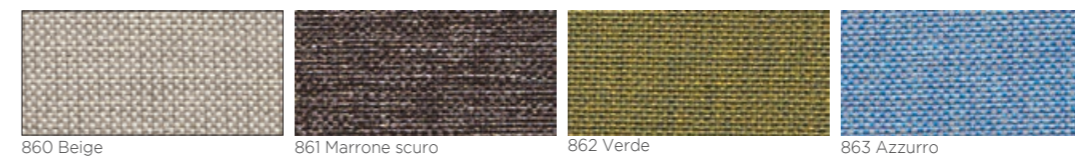

CAT. D - FABRIC STOPFIRE / TESSUTO STOPFIRE / TISSU STOPFIRE



CAT. H - FABRIC LUNA 2 / TESSUTO LUNA 2 / TISSU LUNA 2

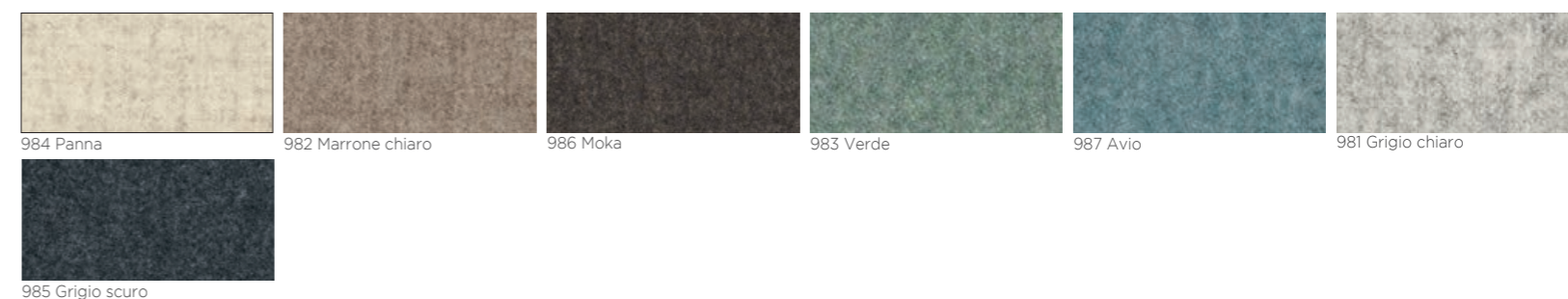

CAT. I - FABRIC CAPTURE / TESSUTO CAPTURE / TISSU CAPTURE

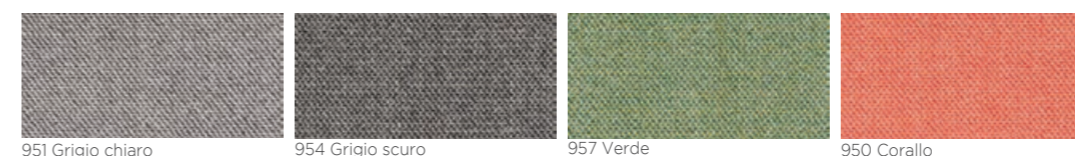

	MEL	LAC	BIANCO 053	NERO 051	ALL FABRICS
Tops th. 14 - 30 mm	•	•			
Legs		•	•	•	
Screen	•	•			•
Modesty	•	•			

Martex reserves the rights at all time to apply modifications for the functional or qualitative improvement of its products. Texts and drawings present in this brochure have a divulgative purpose: for every technical and dimensional aspect please refer to the company's price lists and their relative updating. The colour and material samples have an indicative value.

Martex si riserva il diritto di apportare, senza preavviso, ogni modifica mirata al miglioramento funzionale e qualitativo dei propri prodotti. Testi e disegni presenti in questo stampato hanno scopo divulgativo: per ogni aspetto tecnico e dimensionale fare riferimento ai listini aziendali e relativi aggiornamenti. I campioni di colori e materiali hanno valore indicativo.

Martex se réserve le droit d'apporter, sans préavis, toute modification utile à améliorer la fonctionnalité et la qualité de ses produits. Les textes et dessins dans ce document sont pour des fins d'information: pour tous les aspects techniques et de dimensions il faut se référer aux tarifs et relatives mises à jour. Les échantillons de couleurs et de matériaux ont une valeur indicative.

Art direction: MKT Martex
Photo & Render: Gabriotti Fotografi
Print: Sinchromia

October 2018

Martex is certified
UNI EN ISO 9001:2015
UNI EN ISO 14001:2015

Martex
via Sagré, 19 - 33080
Prata di Pordenone (PN) Italy
tel +39 0434 602310
fax +39 0434 602319
info@martex.it

